

# 22-Bit, Low-Power, 5MHz to 10MHz Serializer and Deserializer Chipsets

## General Description

The MAX9223/MAX9224 serializer/deserializer chipsets reduce wiring by serializing 22 bits onto a single differential pair. 22 bits are serialized in each cycle of the parallel input clock resulting in a 110Mbps to 220Mbps net serial-data rate ideal for cell phone QVGA and QCIF displays. The MAX9223 serializes the 18-bit RGB, VSYNC, HSYNC, and two control signals from the baseband processor to reduce wiring through the hinge to the LCD controller. The 2-wire serial interface uses low-current differential signaling (LCDS) for low EMI, high common-mode noise immunity, and ground-shift tolerance. The MAX9223/MAX9224 automatically identify the word boundary in serial data in case of signal interruption. The MAX9224 power-down is controlled by the MAX9223. The MAX9223 and MAX9224 consume 3.5 $\mu$ A or less in power-down mode.

The MAX9223 serializer operates from a single +2.375V to +3.465V supply and accepts +1.71V to +3.465V inputs. The MAX9224 deserializer operates from a +2.375V to +3.465V core supply and has a separate output buffer supply (V<sub>DDO</sub>), allowing +1.71V to +3.465V output high levels.

The MAX9223/MAX9224 are specified over the -40°C to +85°C extended temperature range and are available in 28-pin TQFN (4mm x 4mm x 0.8mm) packages with an exposed paddle.

## Applications

Cell Phones  
LCDs  
Digital Cameras

## Features

- ◆ Ideal for Serializing Cell Phone LCD or Imager Parallel Interface
- ◆ MAX9223 Serializes 18-Bit RGB, VSYNC, HSYNC, and Two Control Signals
- ◆ LCDS Rejects Common-Mode Noise
- ◆ Automatic Location of Word Boundary After Signal Interruption
- ◆ Power-Down Control Through the Serial Link
- ◆ Power-Down Supply Current  
0.5 $\mu$ A (max)—MAX9223  
3.0 $\mu$ A (max)—MAX9224
- ◆ +2.375V to +3.465V Core Supply Voltage
- ◆ Parallel I/O Interfaces Directly to 1.8V to 3.3V Logic
- ◆  $\pm$ 15kV Human Body Model ESD Protection
- ◆ -40°C to +85°C Operating Temperature Range

## Ordering Information

PART	TEMP RANGE	PIN-PACKAGE	PKG CODE
MAX9223ETI	-40°C to +85°C	28 TQFN-EP*	T2844-1
MAX9223ETI+	-40°C to +85°C	28 TQFN-EP*	T2844-1
MAX9224ETI	-40°C to +85°C	28 TQFN-EP*	T2844-1
MAX9224ETI+	-40°C to +85°C	28 TQFN-EP*	T2844-1

+Denotes lead-free package.

\*EP = Exposed paddle.

Pin Configurations appear at end of data sheet.

## Typical Application Circuit

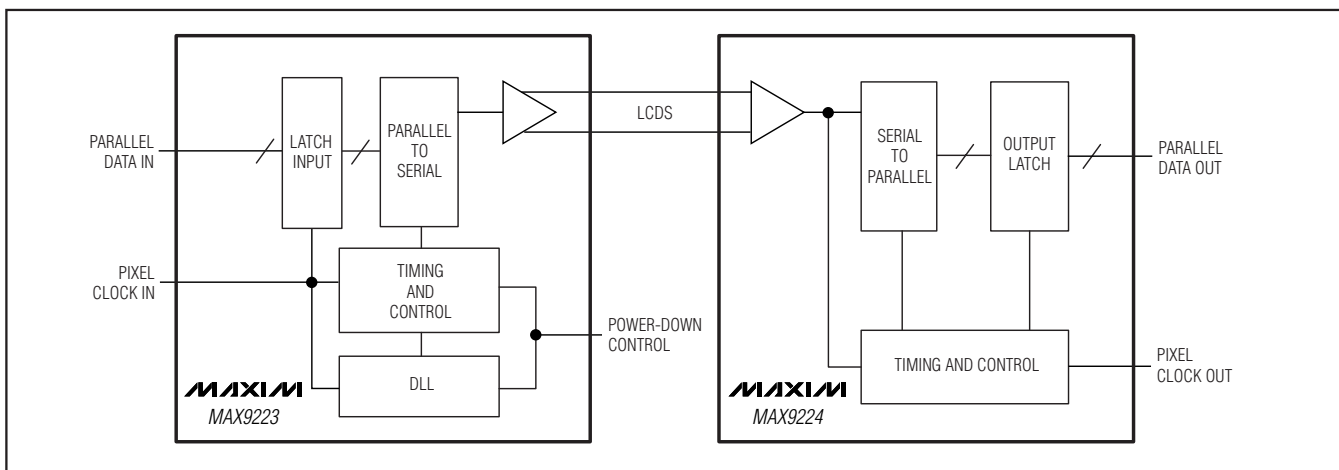

# 22-Bit, Low-Power, 5MHz to 10MHz Serializer and Deserializer Chipset

## ABSOLUTE MAXIMUM RATINGS

V <sub>DD</sub> to GND .....	-0.5V to +4.0V	Single-Layer PCB (derate 20.8mW/°C above +70°C).....	1667mW
V <sub>DDO</sub> to GND.....	-0.5V to +4.0V	Storage Temperature Range .....	-65°C to +150°C
Serial Interface (SDO+, SDO-, SDI+, SDI-) to GND .....	-0.5V to +4.0V	Junction Temperature .....	+150°C
Single-Ended Inputs (DIN_, PCLKIN, PWRDN) to GND .....	-0.5V to (V <sub>DD</sub> + 0.5V)	Lead Temperature (soldering, 10s) .....	+300°C
Single-Ended Outputs (DOUT_, PCLKOUT) to GND .....	-0.5V to (V <sub>DDO</sub> + 0.5V)	ESD Protection (Human Body Model)	
Continuous Power Dissipation (T <sub>A</sub> = +70°C)		SDO+, SDO-, SDI+, SDI- to GND .....	> ±15kV
28-Pin TQFN (4mm x 4mm x 0.8mm)		All Other Pins .....	> ±2kV
Multilayer PCB (derate 28.6mW/°C above +70°C).....	2286mW		

Stresses beyond those listed under "Absolute Maximum Ratings" may cause permanent damage to the device. These are stress ratings only, and functional operation of the device at these or any other conditions beyond those indicated in the operational sections of the specifications is not implied. Exposure to absolute maximum rating conditions for extended periods may affect device reliability.

## DC ELECTRICAL CHARACTERISTICS—MAX9223

(V<sub>DD</sub> = +2.375V to +3.465V, T<sub>A</sub> = -40°C to +85°C, unless otherwise noted. Typical values are at V<sub>DD</sub> = +2.5V, T<sub>A</sub> = +25°C.) (Notes 1, 2)

PARAMETER	SYMBOL	CONDITIONS	MIN	TYP	MAX	UNITS
<b>SINGLE-ENDED INPUTS (PCLKIN, DIN_, PWRDN)</b>						
High-Level Input Voltage	V <sub>IH</sub>		1.19	V <sub>DD</sub> + 0.3		V
Low-Level Input Voltage	V <sub>IL</sub>		-0.3	+0.3		V
Input Current	I <sub>IN</sub>	V <sub>IN</sub> = 0V to V <sub>DD</sub>	-20		+20	μA
		-0.3V ≤ V <sub>IN</sub> < 0V	-100		+100	
		V <sub>DD</sub> < V <sub>IN</sub> ≤ (V <sub>DD</sub> + 0.3V)				
<b>LCDS OUTPUT (SDO+, SDO-)</b>						
Differential Output Current (Note 3)	I <sub>ODH</sub>	High level	600	643	880	μA
	I <sub>ODL</sub>	Low level	200	229	300	
Output Short-Circuit Current	I <sub>OS</sub>	Shorted to 0V or V <sub>DD</sub>			880	μA
<b>POWER SUPPLY</b>						
Supply Current	I <sub>DD</sub>	V <sub>DD</sub> = 2.5V, DIN_ = all low or all high	PCLKIN = 5MHz (110Mbps)	4.4	8.2	mA
			PCLKIN = 10MHz (220Mbps)	5.6	8.2	
Worst-Case Pattern Supply Current	I <sub>DDW</sub>	V <sub>DD</sub> = 2.5V, Figure 1	PCLKIN = 5MHz (110Mbps)	4.1	10.6	mA
			PCLKIN = 10MHz (220Mbps)	5.4	10.6	
Power-Down Supply Current	I <sub>DDZ</sub>	All inputs = low			0.5	μA

# 22-Bit, Low-Power, 5MHz to 10MHz Serializer and Deserializer Chipset

MAX9223/MAX9224

## DC ELECTRICAL CHARACTERISTICS—MAX9224

(V<sub>DD</sub> = +2.375V to +3.465V, V<sub>DDO</sub> = +1.71V to +3.465V, T<sub>A</sub> = -40°C to +85°C, unless otherwise noted. Typical values are at V<sub>DD</sub> = V<sub>DDO</sub> = +2.5V, T<sub>A</sub> = +25°C.) (Notes 1, 2)

PARAMETER	SYMBOL	CONDITIONS	MIN	TYP	MAX	UNITS
<b>SINGLE-ENDED OUTPUTS (PCLKOUT, DOUT_)</b>						
High-Level Output Voltage	V <sub>OH</sub>	V <sub>DDO</sub> = +2.375V to +3.465V, I <sub>OH</sub> = -1mA	0.8 x V <sub>DDO</sub>			V
Low-Level Output Voltage	V <sub>OL</sub>	V <sub>DDO</sub> = +2.375V to +3.465V, I <sub>OL</sub> = 1mA			0.2	V
Output Short-Circuit Current	I <sub>OS</sub>	Output shorted to ground	V <sub>DDO</sub> = 2.375V	-2		mA
			V <sub>DDO</sub> = 3.135V	-9		
			V <sub>DDO</sub> = 3.465V	-25		
<b>LCDS INPUT (SDI+, SDI-)</b>						
Differential Input-Current Threshold	I <sub>ID</sub>			400		μA
Common-Mode Input Current	I <sub>IC</sub>		-300	±500	+300	μA
Differential Input Impedance	Z <sub>ID</sub>	I <sub>IC</sub> = 0μA at V <sub>DD</sub> = 3.3V ±5%	69	90	109	Ω
		I <sub>IC</sub> = 0μA at V <sub>DD</sub> = 2.8V ±5%	82	108	132	
		I <sub>IC</sub> = 0μA at V <sub>DD</sub> = 2.5V ±5%	95	125	153	
		I <sub>IC</sub> = ±300μA at V <sub>DD</sub> = 3.3V ±5%	67	91	112	
		I <sub>IC</sub> = ±300μA at V <sub>DD</sub> = 2.8V ±5%	86	108	136	
Common-Mode Input Impedance	Z <sub>IC</sub>	I <sub>IC</sub> = ±300μA	90	167	375	Ω
Input Capacitance	C <sub>IN</sub>	SDI+ or SDI- to ground		2		pF
<b>POWER SUPPLY</b>						
Supply Current (Note 4)	I <sub>TOT</sub>	V <sub>DD</sub> = V <sub>DDO</sub> = 2.5V DOUT_ = all high or all low	PCLKOUT = 5MHz (110Mbps)	9	12	mA
			PCLKOUT = 10MHz (220Mbps)	9	12	
Worst-Case Pattern Supply Current (Note 4)	I <sub>TOTW</sub>	C <sub>L</sub> = 5pF, V <sub>DD</sub> = V <sub>DDO</sub> = 2.5V, Figure 2	PCLKOUT = 5MHz (110Mbps)	10	12	mA
			PCLKOUT = 10MHz (220Mbps)	10	12	
Power-Down Supply Current (Note 4)	I <sub>TOTZ</sub>			0.08	3	μA
Supply Difference	V <sub>SD</sub>	MAX9223 V <sub>DD</sub> to MAX9224 V <sub>DD</sub>	-5		+5	%
<b>GROUND POTENTIAL</b>						
Ground Difference	V <sub>GD</sub>	MAX9223 to MAX9224 ground difference	-0.2		+0.2	V

# 22-Bit, Low-Power, 5MHz to 10MHz Serializer and Deserializer Chipset

## AC ELECTRICAL CHARACTERISTICS—MAX9223

( $V_{DD} = +2.375V$  to  $+3.465V$ ,  $T_A = -40^{\circ}C$  to  $+85^{\circ}C$ , unless otherwise noted. Typical values are at  $V_{DD} = +2.5V$ ,  $T_A = +25^{\circ}C$ .) (Note 3)

PARAMETER	SYMBOL	CONDITIONS	MIN	TYP	MAX	UNITS
<b>PCLKIN INPUT REQUIREMENTS (Figure 3)</b>						
Input Rise Time	$t_R$				2	ns
Input Fall Time	$t_F$				2	ns
PCLKIN Period	$t_P$		100		200	ns
High-Level Pulse Width	$t_{PWH}$		$0.3 \times t_P$		$0.7 \times t_P$	ns
Low-Level Pulse Width	$t_{PWL}$		$0.3 \times t_P$		$0.7 \times t_P$	ns
Setup Time	$t_S$		3			ns
Hold Time	$t_H$		1			ns

## AC ELECTRICAL CHARACTERISTICS—MAX9224

( $V_{DD} = V_{DDO} = +2.375V$  to  $+3.465V$ ,  $C_L = 5pF$ ,  $T_A = -40^{\circ}C$  to  $+85^{\circ}C$ , unless otherwise noted. Typical values are at  $V_{DD} = V_{DDO} = +2.5V$ ,  $T_A = +25^{\circ}C$ .) (Notes 3, 5)

PARAMETER	SYMBOL	CONDITIONS	MIN	TYP	MAX	UNITS
PCLKOUT Period	$t_P$	Figure 4	100		200	ns
High-Level Pulse Width	$t_{PWH}$	Figure 4	$0.4 \times t_P$		$0.6 \times t_P$	ns
Low-Level Pulse Width	$t_{PWL}$	Figure 4	$0.4 \times t_P$		$0.6 \times t_P$	ns
Data Valid Before PCLKOUT	$t_{VB}$	Figure 4	5			ns
Data Valid After PCLKOUT	$t_{VA}$	Figure 4	5			ns
<b>SERIALIZER AND DESERIALIZER LINK</b>						
Power-Up Time	$t_{PU1}$	From $V_{DD} = V_{DDO} = 2.375V$ when supplies are ramping up			$6144 \times t_P$	ns
	$t_{PU2}$	From $\overline{PWRDN}$ low to high			$4096 \times t_P$	
Power-Down Time	$t_{PWRDN}$	From $\overline{PWRDN}$ high to low		2.8	10	$\mu s$

**Note 1:** Current into a pin is defined as positive. Current out of a pin is defined as negative. All voltages are referenced to ground.

**Note 2:** Maximum and minimum limits over temperature are guaranteed by design and characterization. Devices are production tested at  $T_A = +85^{\circ}C$ .

**Note 3:** Parameters are guaranteed by design and characterization, and are not production tested. Limits are set at  $\pm 6$  sigma.

**Note 4:**  $I_{TOT} = I_{DD} + I_{DDO}$ .

**Note 5:**  $C_L$  includes probe and test jig capacitance.

# 22-Bit, Low-Power, 5MHz to 10MHz Serializer and Deserializer Chipset

MAX9223/MAX9224

## Test Circuits/Timing Diagrams

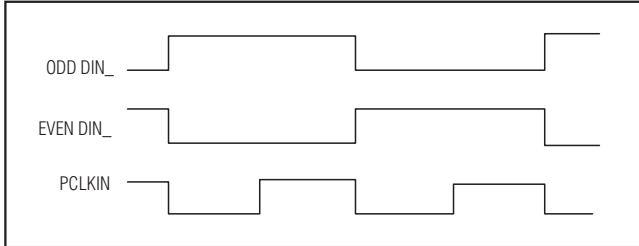

Figure 1. Serializer Worst-Case Switching Pattern

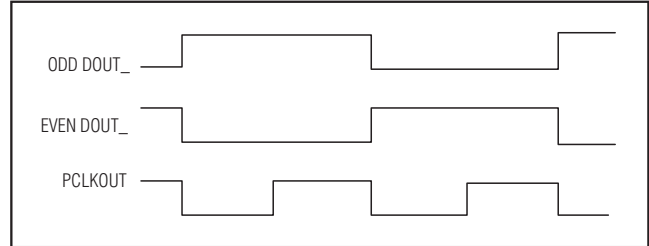

Figure 2. Deserializer Worst-Case Switching Pattern

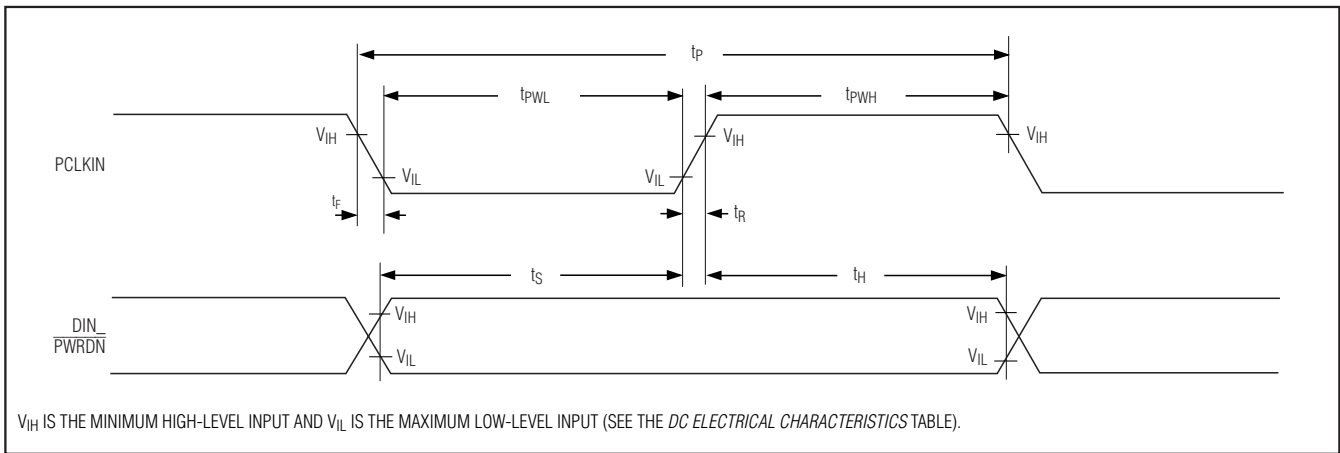

Figure 3. Serializer Input Timing

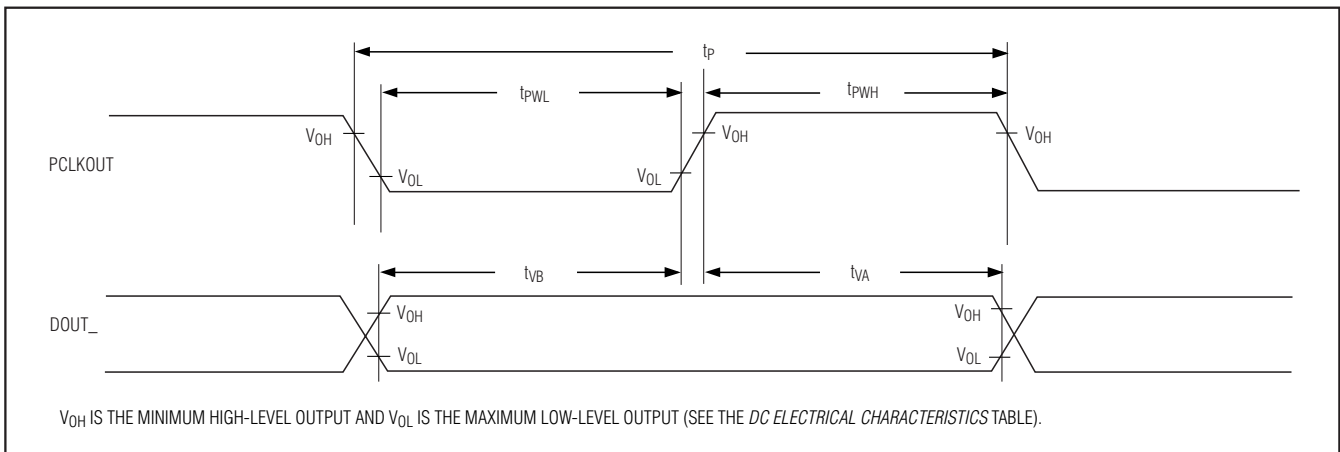
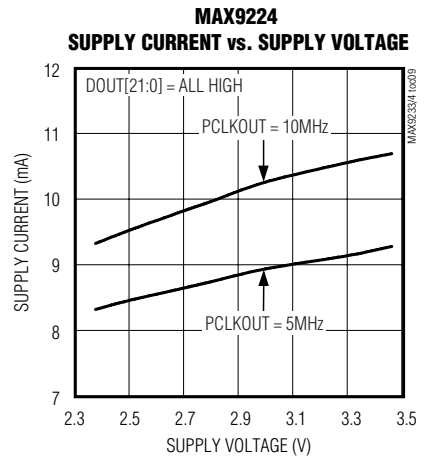
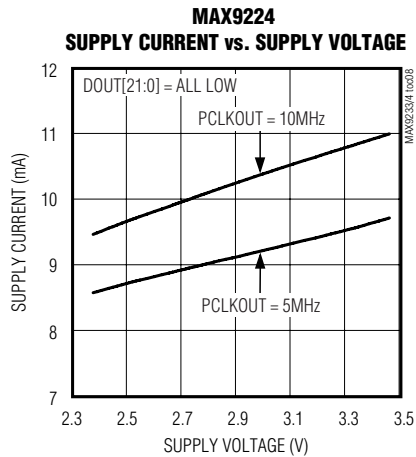
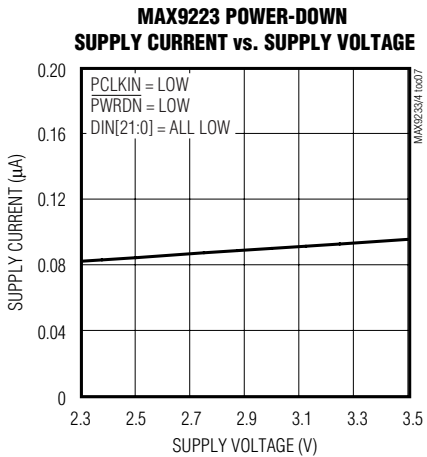
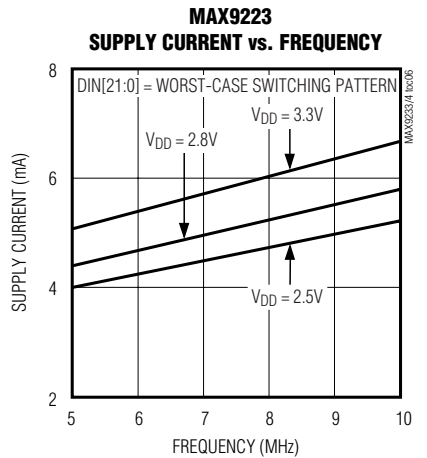
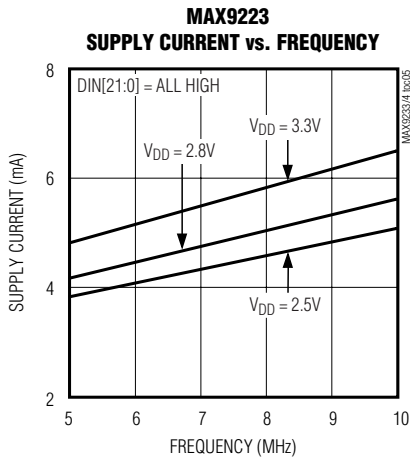
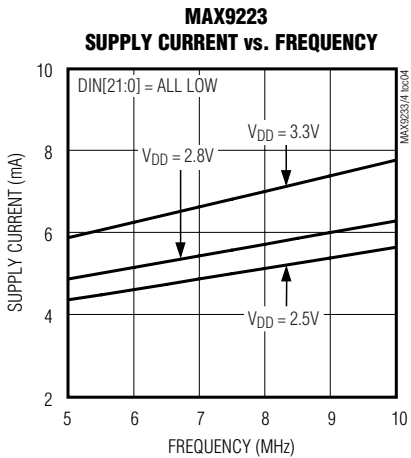
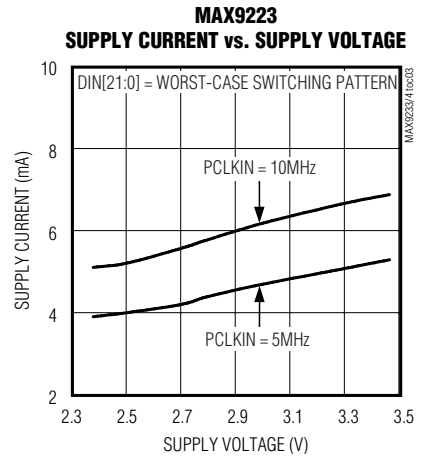
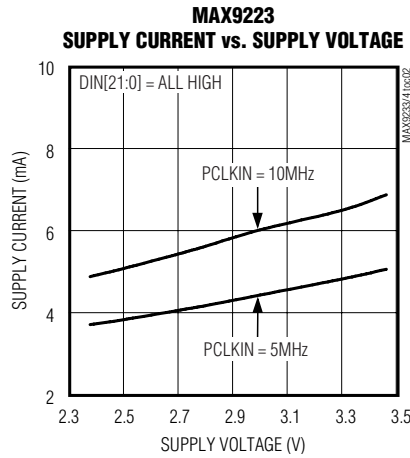
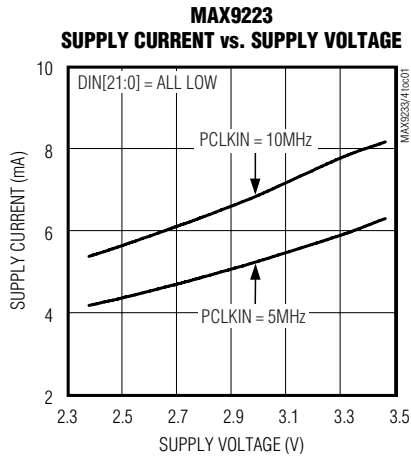

Figure 4. Deserializer Output Timing

# 22-Bit, Low-Power, 5MHz to 10MHz Serializer and Deserializer Chipset

## Typical Operating Characteristics

( $V_{DD} = V_{DDO} = +2.8V$ , logic input levels = 0 to +2.8V, logic output load  $C_L = 5pF$ ,  $T_A = +25^\circ C$ , unless otherwise noted.)



# 22-Bit, Low-Power, 5MHz to 10MHz Serializer and Deserializer Chipset

MAX9223/MAX9224

## Typical Operating Characteristics (continued)

( $V_{DD} = V_{DDO} = +2.8V$ , logic input levels = 0 to +2.8V, logic output load  $C_L = 5pF$ ,  $T_A = +25^\circ C$ , unless otherwise noted.)

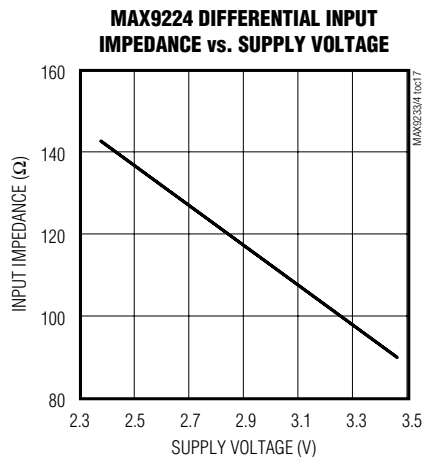
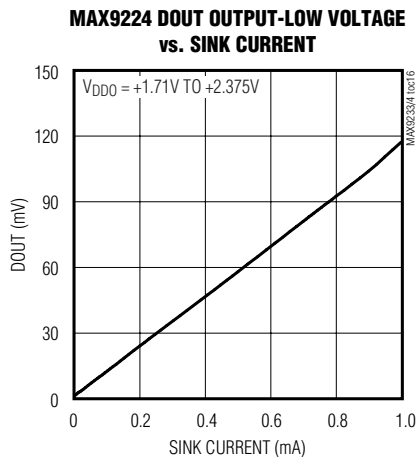
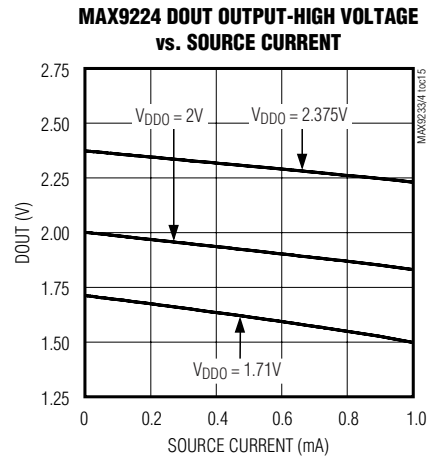
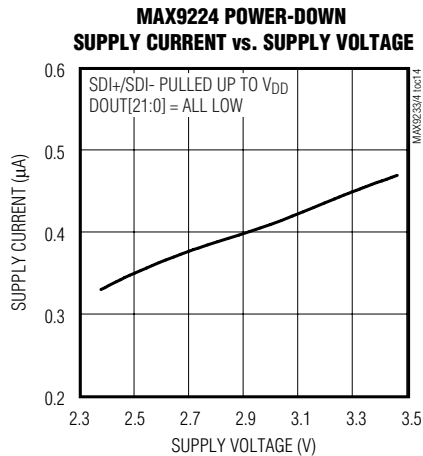
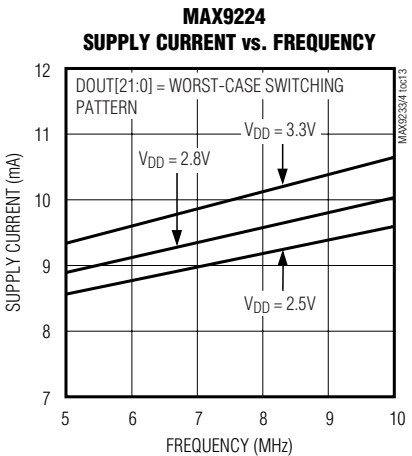
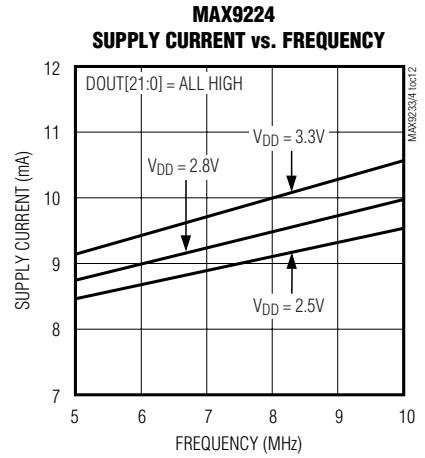
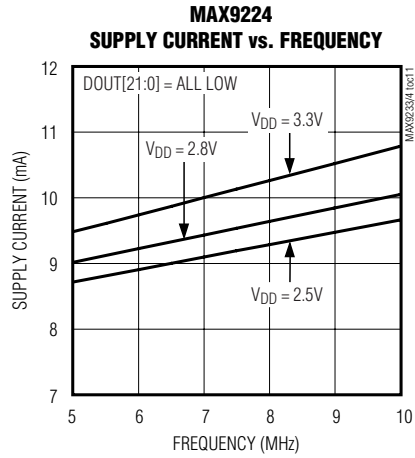
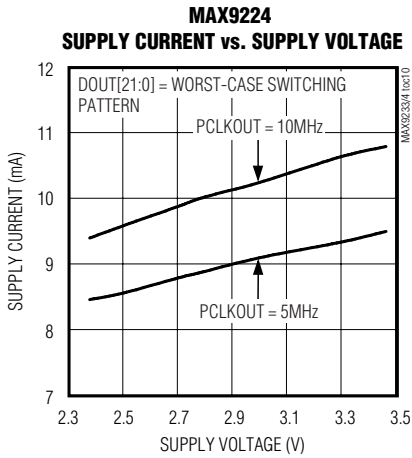

# 22-Bit, Low-Power, 5MHz to 10MHz Serializer and Deserializer Chipset

## Pin Description (MAX9223)

PIN	NAME	FUNCTION
1–12, 14, 15, 21–28	DIN13–DIN2, DIN1, DIN0, DIN21–DIN14	Single-Ended Parallel Data Inputs. The 22 data bits are loaded into the input latch on the rising edge of PCLKIN. DIN[21:0] are 1.71V to 3.465V tolerant. Internally pulled down to GND.
13	PCLKIN	Parallel Clock Input. The rising edge of PCLKIN (typically the pixel clock) latches the parallel data input. Internally pulled down to GND.
16	$\overline{\text{PWRDN}}$	Power-Down Input. Pull $\overline{\text{PWRDN}}$ low to place the MAX9223 and MAX9224 in power-down mode. Drive $\overline{\text{PWRDN}}$ high for normal operation. Internally pulled down to GND.
17	SDO-	Inverting LCDS Serial-Data Output
18	SDO+	Noninverting LCDS Serial-Data Output
19	GND	Ground
20	V <sub>DD</sub>	Core Supply Voltage. Bypass to GND with 0.1 $\mu$ F and 0.01 $\mu$ F capacitors in parallel as close to the device as possible, with the smallest value capacitor closest to the supply pin.
—	EP	Exposed Paddle. Connect EP to ground.

## Pin Description (MAX9224)

PIN	NAME	FUNCTION
1, 7, 8, 10–28	DOUT21, DOUT0, DOUT1, DOUT2–DOUT20	Single-Ended Parallel Data Outputs. DOUT[21:0] are valid on the rising edge of PCLKOUT.
2	V <sub>DDO</sub>	Output Supply Voltage. Bypass to GND with 0.1 $\mu$ F and 0.01 $\mu$ F capacitors in parallel as close to the device as possible, with the smallest value capacitor closest to the supply pin.
3	GND	Ground
4	SDI+	Noninverting LCDS Serial-Data Input
5	SDI-	Inverting LCDS Serial-Data Input
6	V <sub>DD</sub>	Core Supply Voltage. Bypass to GND with 0.1 $\mu$ F and 0.01 $\mu$ F capacitors in parallel as close to the device as possible, with the smallest value capacitor closest to the supply pin.
9	PCLKOUT	Parallel Clock Output. Parallel output data are valid on the rising edge of PCLKOUT (typically the pixel clock).
—	EP	Exposed Paddle. Connect EP to ground.



# 22-Bit, Low-Power, 5MHz to 10MHz Serializer and Deserializer Chipset

MAX9223/MAX9224

**MAX9223 Functional Diagram**

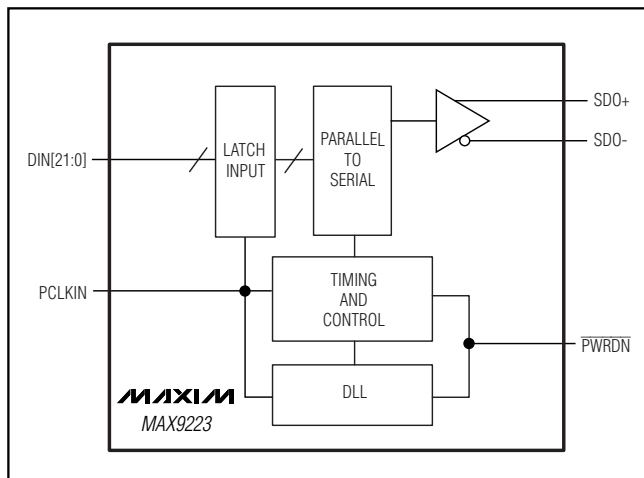

**MAX9224 Functional Diagram**

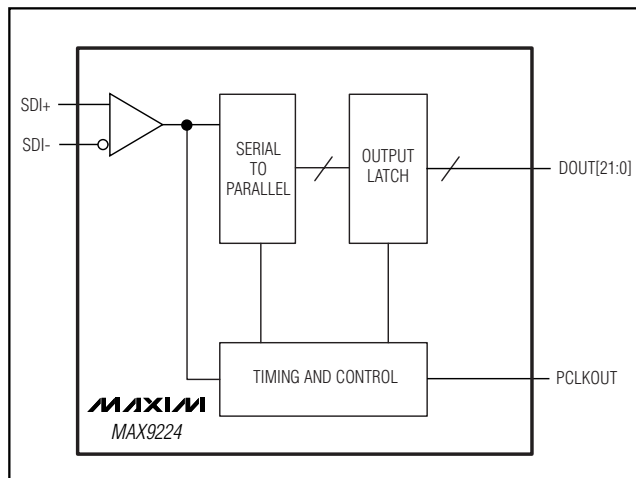

## Detailed Description

The MAX9223 serializer operates at a 5MHz to 10MHz parallel clock frequency, serializing 22 bits of parallel input data DIN[21:0] in each cycle of the parallel clock. DIN[21:0] are latched on the rising edge of PCLKIN. The data and internally generated serial clock are combined and transmitted through SDO+/SDO- using multilevel LCDS. The MAX9224 deserializer receives the LCDS signal on SDI+/SDI-. The deserialized data and recovered parallel clock are available at DOUT[21:0]

and PCLKOUT. Output data is valid on the rising edge of PCLKOUT.

The first bit (G) is internally grounded and transmitted first. Bit 0 (DIN[0]) is the first valid data bit. Boundary bits OH are used by the MAX9224 deserializer to identify the word boundary and are the inverse polarity of data bit 21 (DIN[21]). Therefore, at least one level transition is guaranteed in one word. The clock is recovered from the serial input.

### Serial word format:

G	0	1	2	3	4	5	6	7	8	9	10	11	12	13	14	15	16	17	18	19	20	21	OH	OH
---	---	---	---	---	---	---	---	---	---	---	----	----	----	----	----	----	----	----	----	----	----	----	----	----

### LCDS

The MAX9223/MAX9224 use a proprietary multilevel LCDS interface. Figure 5 provides a representation of the data and clock in the multilevel LCDS interface. This interface offers advantages over other chipsets, such as requiring only one differential pair as the transmission medium, the inherently aligned data and clock, and much smaller current levels than the 4mA typically found in traditional LVDS interfaces.

### MAX9223/MAX9224 Handshaking

The handshaking function of the MAX9223/MAX9224 provides bidirectional communication between the two devices in case a word boundary error is detected. Prior

to data transmission, the MAX9223 serializer adds boundary bits (OH) to the end of the latched word. These boundary bits are the inverse of the last bit of the latched word. During data transmission, the MAX9224 deserializer continuously monitors the state of the boundary bits of each word. If a word boundary error is detected, the serial link is pulled up to V<sub>DD</sub> and the MAX9224 powers down. The MAX9223 detects the pullup of the serial link and powers down for 1.0μs. After 1.0μs, the MAX9223 powers up, causing the power-up of the MAX9224. Then the word boundary is reestablished, and data transfer resumes. The handshaking function is disabled when PWRDN is pulled low.

## 22-Bit, Low-Power, 5MHz to 10MHz Serializer and Deserializer Chipset

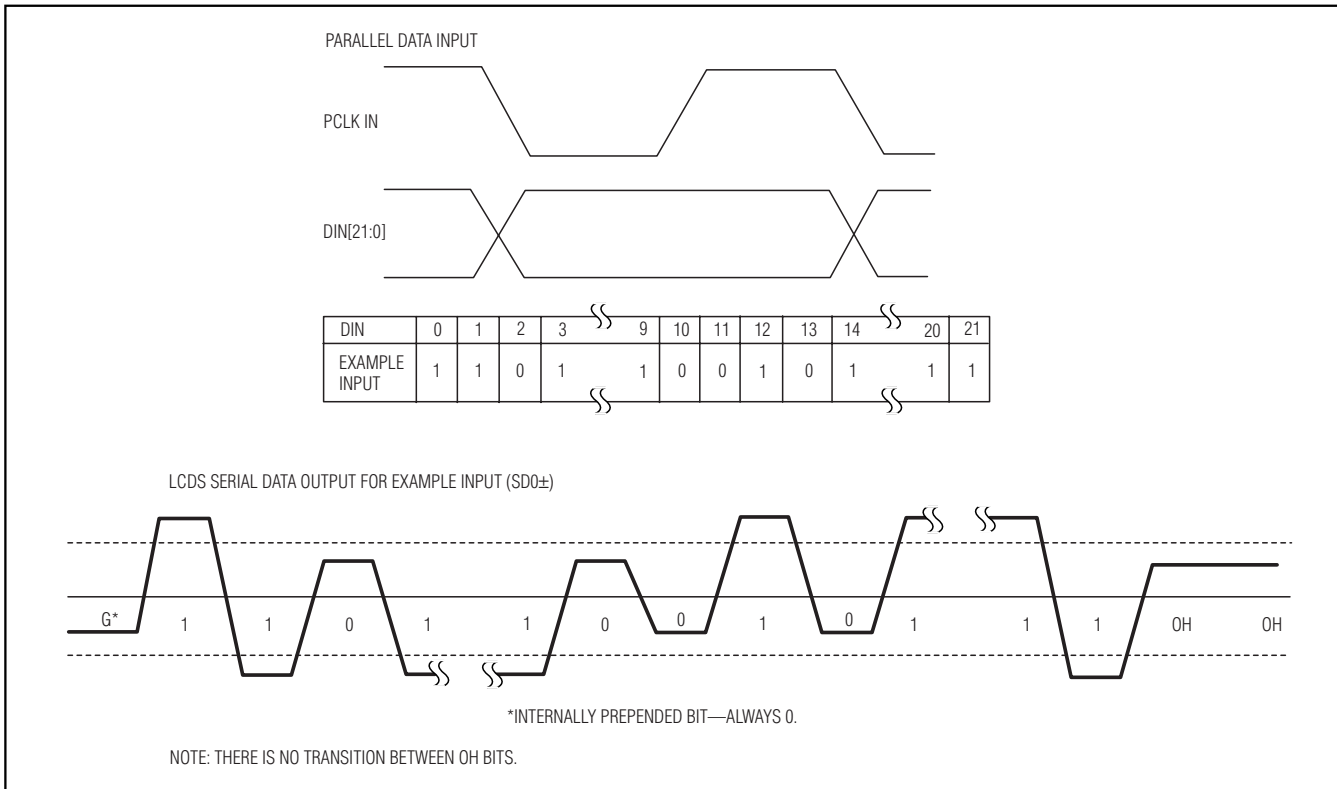

Figure 5. Multilevel LCDS Output Representation

### Applications Information

#### PCLKIN Latch Edge

The parallel data input of the MAX9223 serializer is latched on the rising edge of PCLKIN. Figure 3 shows the serializer input timing.

#### PCLKOUT Strobe

The serial-data output of the MAX9224 deserializer is valid on the rising edge of PCLKOUT. Figure 4 shows the deserializer output timing.

#### Power-Down and Power-Up

Driving  $\overline{\text{PWRDN}}$  low puts the MAX9223 in power-down mode and sends a pulse to power down the MAX9224. In power-down mode, the DLL is stopped, SDO+/SDO- are high impedance to ground and differential, and the LCDS link is weakly biased around  $V_{DD} - 0.8V$ . With  $\overline{\text{PWRDN}}$  and all inputs low, the combined MAX9223/MAX9224 supply current is reduced to 3.5 $\mu$ A or less.

Driving  $\overline{\text{PWRDN}}$  high starts DLL lock to PCLKIN and initiates a MAX9224 power-up sequence. The MAX9223

LCDS output is not driven until the DLL locks. 4096 clock cycles are required for the power-up and link synchronization, before valid DIN can be latched. See Figure 6 for an overall power-up and power-down timing diagram. For normal operation, PCLKIN must be running and settled before driving  $\overline{\text{PWRDN}}$  high.

If  $V_{DD} = 0$ , the LCDS outputs are high impedance to ground and differential.

#### Ground-Shift Tolerance

The MAX9223/MAX9224 are designed to function normally in the event of a slight shift in ground potential. However, the MAX9224 deserializer ground must be within  $\pm 0.2V$  relative to the MAX9223 serializer ground to maintain proper operation.

#### MAX9224 Output Buffer Supply (VDDO)

The MAX9224 parallel outputs are powered from VDDO, which accepts a +1.71V to +3.465V supply, allowing direct interface to inputs with 1.8V to 3.3V logic levels.

# 22-Bit, Low-Power, 5MHz to 10MHz Serializer and Deserializer Chipset

MAX9223/MAX9224

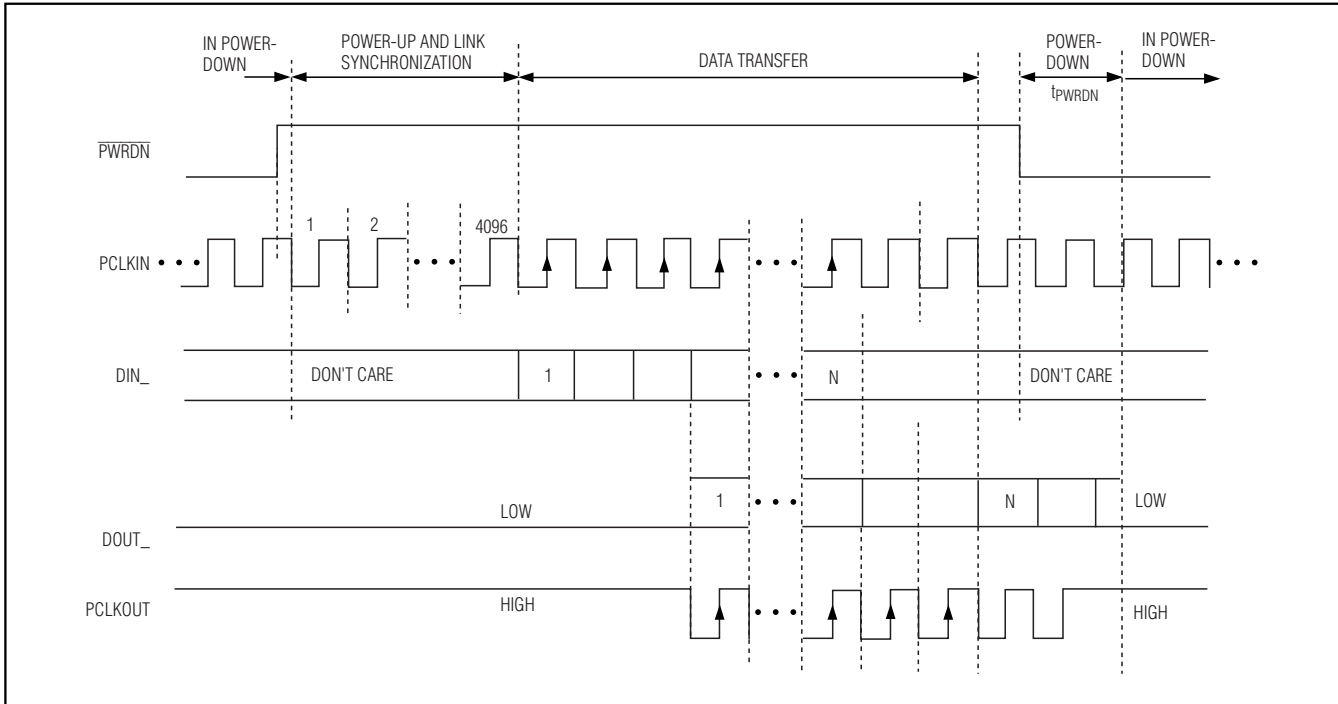

Figure 6. MAX9223/MAX9224 Power-Up/Power-Down Sequence

## Flex Cable, PCB Interconnect, and Connectors

Interconnect for LCDS typically has a differential impedance of  $110\Omega$ . Use interconnect and connectors that have matched differential impedance to minimize impedance discontinuities.

## Board Layout and Supply Bypassing

Separate the logic and LCDS signals to prevent crosstalk. A PCB or flex with separate layers for power, ground, and signals is recommended.

Bypass each  $V_{DD}$  and  $V_{DDO}$  pin with high-frequency, surface-mount ceramic  $0.1\mu\text{F}$  and  $0.01\mu\text{F}$  capacitors in parallel as close to the device as possible, with the smallest value capacitor closest to the supply pin.

## ESD Protection

The MAX9223/MAX9224 LCDS inputs and outputs (SDO+/SDO-, SDI+/SDI-) are rated for  $\pm 15\text{kV}$  ESD protection using the Human Body Model. The Human Body Model discharge components are  $C_S = 100\text{pF}$  and  $R_D = 1.5\text{k}\Omega$  (Figure 7).

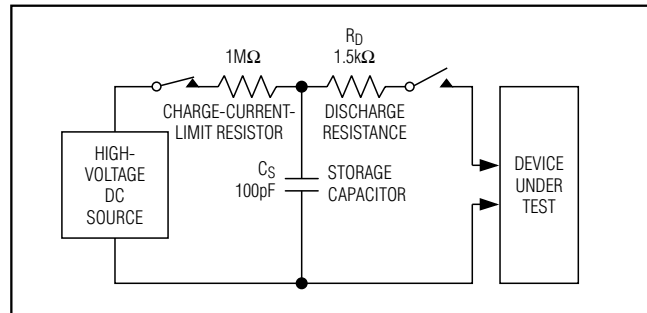

Figure 7. Human Body Model ESD Test Circuit

## Chip Information

PROCESS: CMOS

# 22-Bit, Low-Power, 5MHz to 10MHz Serializer and Deserializer Chipset

## Pin Configurations

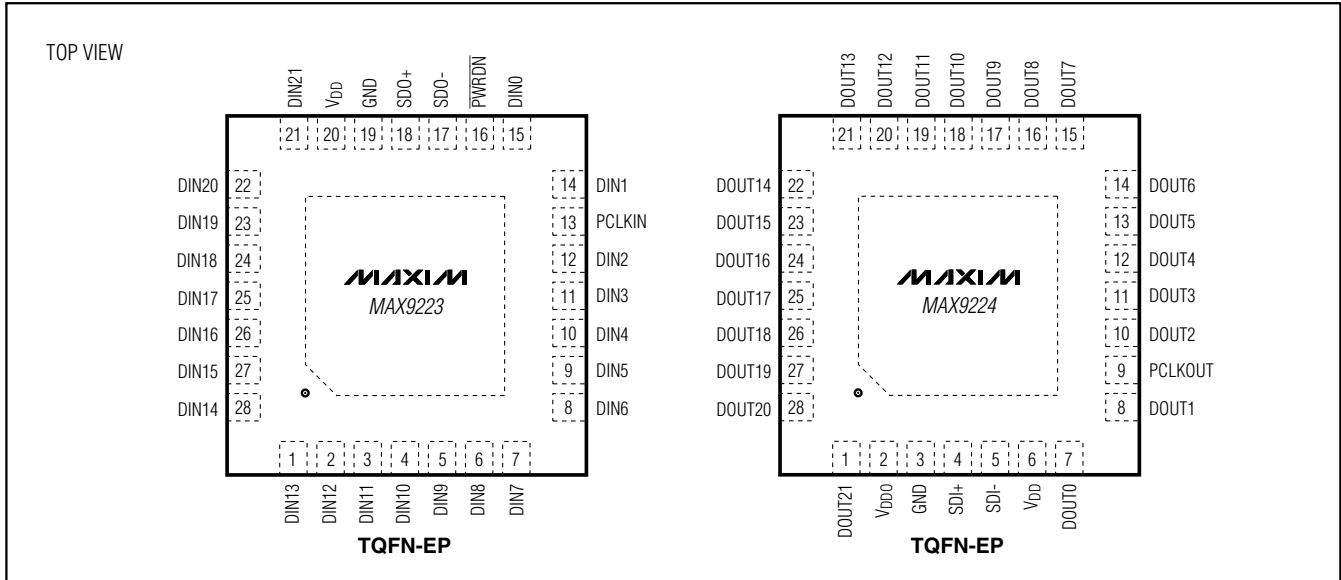

# 22-Bit, Low-Power, 5MHz to 10MHz Serializer and Deserializer Chipset

## Package Information

(The package drawing(s) in this data sheet may not reflect the most current specifications. For the latest package outline information, go to [www.maxim-ic.com/packages](http://www.maxim-ic.com/packages).)

MAX9223/MAX9224

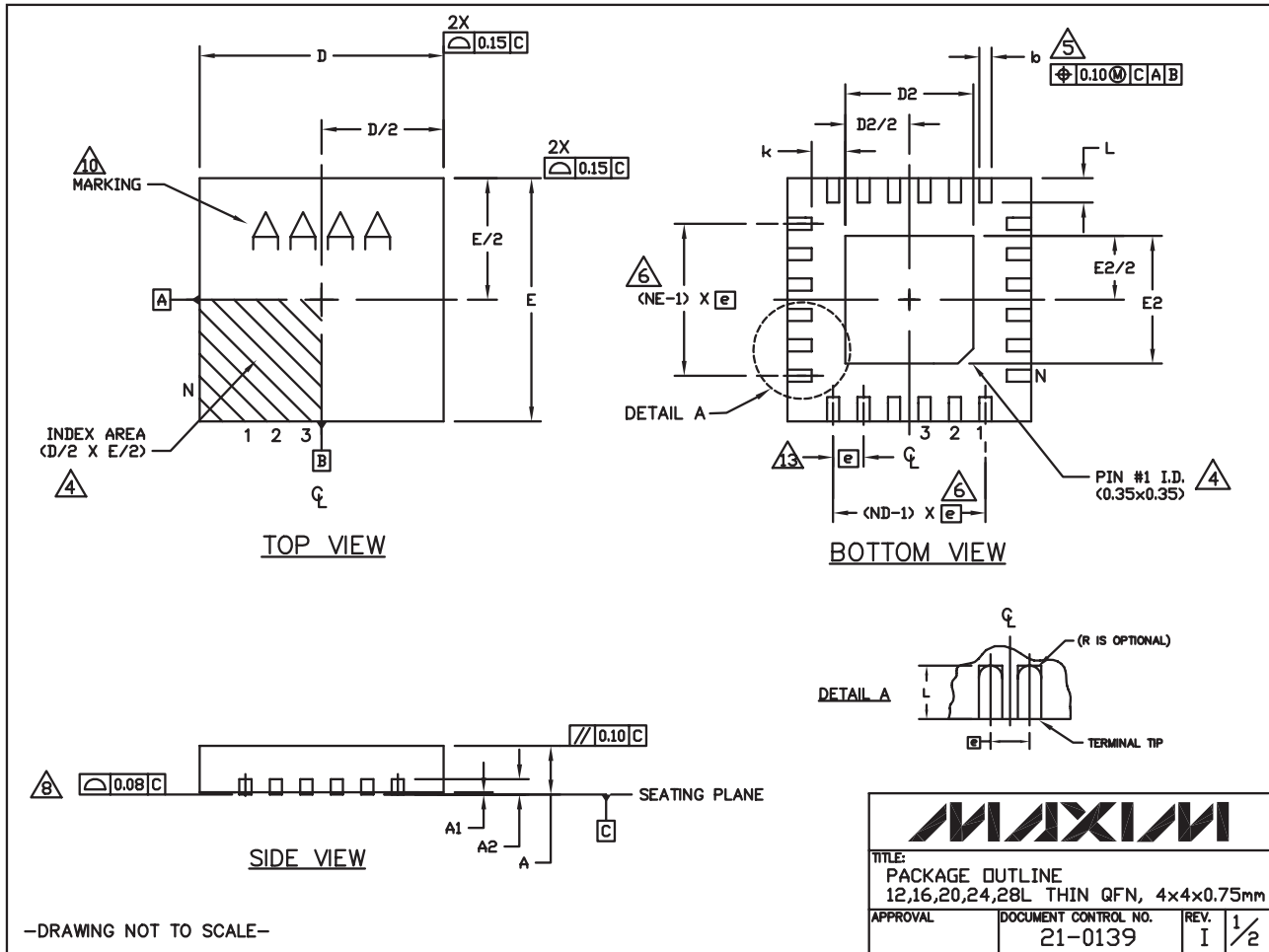

# 22-Bit, Low-Power, 5MHz to 10MHz Serializer and Deserializer Chipset

## Package Information (continued)

(The package drawing(s) in this data sheet may not reflect the most current specifications. For the latest package outline information go to [www.maxim-ic.com/packages](http://www.maxim-ic.com/packages).)

COMMON DIMENSIONS															
PKG	12L 4x4			16L 4x4			20L 4x4			24L 4x4			28L 4x4		
REF.	MIN.	NOM.	MAX.	MIN.	NOM.	MAX.	MIN.	NOM.	MAX.	MIN.	NOM.	MAX.	MIN.	NOM.	MAX.
A	0.70	0.75	0.80	0.70	0.75	0.80	0.70	0.75	0.80	0.70	0.75	0.80	0.70	0.75	0.80
A1	0.0	0.02	0.05	0.0	0.02	0.05	0.0	0.02	0.05	0.0	0.02	0.05	0.0	0.02	0.05
A2	0.20 REF.			0.20 REF.			0.20 REF.			0.20 REF.			0.20 REF.		
b	0.25	0.30	0.35	0.25	0.30	0.35	0.20	0.25	0.30	0.18	0.23	0.30	0.15	0.20	0.25
D	3.90	4.00	4.10	3.90	4.00	4.10	3.90	4.00	4.10	3.90	4.00	4.10	3.90	4.00	4.10
E	3.90	4.00	4.10	3.90	4.00	4.10	3.90	4.00	4.10	3.90	4.00	4.10	3.90	4.00	4.10
e	0.80 BSC.			0.65 BSC.			0.50 BSC.			0.50 BSC.			0.40 BSC.		
k	0.25	-	-	0.25	-	-	0.25	-	-	0.25	-	-	0.25	-	-
L	0.45	0.55	0.65	0.45	0.55	0.65	0.45	0.55	0.65	0.30	0.40	0.50	0.30	0.40	0.50
N	12			16			20			24			28		
ND	3			4			5			6			7		
NE	3			4			5			6			7		
JeDEC Var.	WGGB			WGGC			WGGD-1			WGGD-2			WGGE		

EXPOSED PAD VARIATIONS						
PKG. CODES	D2			E2		
	MIN.	NOM.	MAX.	MIN.	NOM.	MAX.
T1244-3	1.95	2.10	2.25	1.95	2.10	2.25
T1244-4	1.95	2.10	2.25	1.95	2.10	2.25
T1644-3	1.95	2.10	2.25	1.95	2.10	2.25
T1644-4	1.95	2.10	2.25	1.95	2.10	2.25
T2044-2	1.95	2.10	2.25	1.95	2.10	2.25
T2044-3	1.95	2.10	2.25	1.95	2.10	2.25
T2444-2	1.95	2.10	2.25	1.95	2.10	2.25
T2444-3	2.45	2.60	2.63	2.45	2.60	2.63
T2444-4	2.45	2.60	2.63	2.45	2.60	2.63
T2444N-4	2.45	2.60	2.63	2.45	2.60	2.63
T2444M-1	2.45	2.60	2.63	2.45	2.60	2.63
T2844-1	2.50	2.60	2.70	2.50	2.60	2.70

NOTES:

- DIMENSIONING & TOLERANCING CONFORM TO ASME Y14.5M-1994.
- ALL DIMENSIONS ARE IN MILLIMETERS. ANGLES ARE IN DEGREES.
- N IS THE TOTAL NUMBER OF TERMINALS.
- THE TERMINAL #1 IDENTIFIER AND TERMINAL NUMBERING CONVENTION SHALL CONFORM TO JESD 95-1 SPP-012. DETAILS OF TERMINAL #1 IDENTIFIER ARE OPTIONAL, BUT MUST BE LOCATED WITHIN THE ZONE INDICATED. THE TERMINAL #1 IDENTIFIER MAY BE EITHER A MOLD OR MARKED FEATURE.
- DIMENSION b APPLIES TO METALLIZED TERMINAL AND IS MEASURED BETWEEN 0.25mm AND 0.30mm FROM TERMINAL TIP.
- ND AND NE REFER TO THE NUMBER OF TERMINALS ON EACH D AND E SIDE RESPECTIVELY.
- DEPOPULATION IS POSSIBLE IN A SYMMETRICAL FASHION.
- COPLANARITY APPLIES TO THE EXPOSED HEAT SINK SLUG AS WELL AS THE TERMINALS.
- DRAWING CONFORMS TO JEDEC MO220, EXCEPT FOR T2444-3, T2444-4 AND T2844-1.
- MARKING IS FOR PACKAGE ORIENTATION REFERENCE ONLY.
- COPLANARITY SHALL NOT EXCEED 0.08mm.
- WARPAGE SHALL NOT EXCEED 0.10mm.
- LEAD CENTERLINES TO BE AT TRUE POSITION AS DEFINED BY BASIC DIMENSION 'e', ±0.05.
- NUMBER OF LEADS SHOWN ARE FOR REFERENCE ONLY.
- ALL DIMENSIONS ARE THE SAME FOR LEADED (-) & PbfREE (+) PACKAGE CODES.

-DRAWING NOT TO SCALE-

TITLE:  
PACKAGE OUTLINE  
12,16,20,24,28L THIN QFN, 4x4x0.75mm

APPROVAL	DOCUMENT CONTROL NO. 21-0139	REV. I	2/2
----------	---------------------------------	-----------	-----

# 22-Bit, Low-Power, 5MHz to 10MHz Serializer and Deserializer Chipset

## Revision History

REVISION NUMBER	REVISION DATE	DESCRIPTION	PAGES CHANGED
0	10/05	Initial release	—
1	12/07	Changed min output short-circuit current from -20 to -25 and updated package outlines.	3, 13

**MAX9223/MAX9224**

Maxim cannot assume responsibility for use of any circuitry other than circuitry entirely embodied in a Maxim product. No circuit patent licenses are implied. Maxim reserves the right to change the circuitry and specifications without notice at any time.

**Maxim Integrated Products, 120 San Gabriel Drive, Sunnyvale, CA 94086 408-737-7600** \_\_\_\_\_ 15